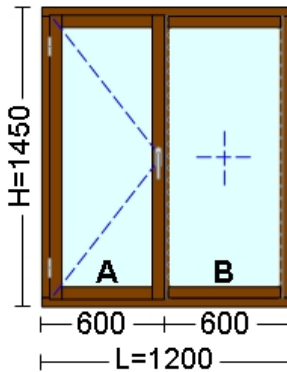
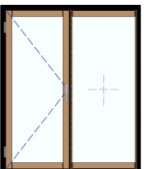
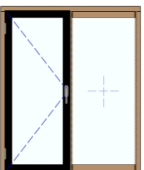
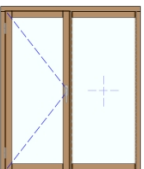
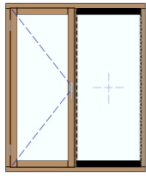

# Execution Plan

Project: OFR06583 - Demo Lemn Stratificat / Date: 12/02/2009  
 Delivery Date: 28/11/2007

 <p>View inner. Opening inner.</p>	<b>Component : 01.F1</b>						
	Size:	1,200.0 mm x 1,450.0 mm					
Profile System:	Molid 68 / Molid						
Hardware:	AGB Standard						
Glass:	GT Clar-Clar 4-14-4						
Surface:						1.740	sqm
Quantity:						3	pcs
	<b>Subcomponent Element :</b>						
	<b>Code</b>	<b>Description</b>	<b>Qty</b>	<b>Dimensions</b>	<b>1°</b>	<b>2°</b>	<b>Pos</b>
	IV68/78 01 2 900 - Mol	Toc Fereastră Mobilă DKD, Bară 900 mm	3 pcs	1,450.0 mm	90°	90°	Lft
	IV68/78 01 2 900 - Mol	Toc Fereastră Mobilă DKD, Bară 900 mm	3 pcs	1,200.0 mm	90°	90°	Down
	IV68/78 01 2 900 - Mol	Toc Fereastră Mobilă DKD, Bară 900 mm	3 pcs	1,450.0 mm	90°	90°	Rght
	IV68/78 01 2 900 - Mol	Toc Fereastră Mobilă DKD, Bară 900 mm	3 pcs	1,200.0 mm	90°	90°	Up
IV68/78 05 2 900 - Mol	Montant DKD, Bară 900 mm	3 pcs	1,364.0 mm	90°	90°	V	
	<b>Subcomponent Element : A</b>						
	<b>Code</b>	<b>Description</b>	<b>Qty</b>	<b>Dimensions</b>	<b>1°</b>	<b>2°</b>	<b>Pos</b>
	IV68/78 02 2 900 - Mol	Canat Fereastră DKD, Bară 900 mm	3 pcs	1,376.0 mm	90°	90°	Lft
	IV68/78 02 2 900 - Mol	Canat Fereastră DKD, Bară 900 mm	3 pcs	557.0 mm	90°	90°	Down
	IV68/78 02 2 900 - Mol	Canat Fereastră DKD, Bară 900 mm	3 pcs	1,376.0 mm	90°	90°	Rght
IV68/78 02 2 900 - Mol	Canat Fereastră DKD, Bară 900 mm	3 pcs	557.0 mm	90°	90°	Up	
	<b>Subcomponent Element : A</b>						
	<b>Code</b>	<b>Description</b>	<b>Qty</b>	<b>Dimensions</b>	<b>1°</b>	<b>2°</b>	<b>Pos</b>
Cl-Cl 4/16/4	GT Clar-Clar 4-14-4	3 pcs	424.0 x 1,243.0 mm				

**Subcomponent Element : B**

Code	Description	Qty	Dimensions	1°	2°	Pos
IV68/78 07 1 6000 - Mol	Profil Compensare FJ, Bara 6000 mm	3 pcs	545.0 mm	90°	90°	Down
IV68/78 07 2 1300 - Mol	Profil Compensare DKD, Bara 1300 mm	3 pcs	545.0 mm	90°	90°	Up

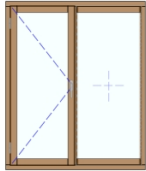
**Subcomponent Element : B**

Code	Description	Qty	Dimensions	1°	2°	Pos
CI-CI 4/16/4	GT Clar-Clar 4-14-4	3 pcs	532.0 x 1,243.0 mm			

**Hardware and Accessories**

Code	Description	Qty	Dimensions	1°	2°
1205	Garnitura	19.170 m			
1208	Garnitura	11.598 m			
475/85	Grund	1.325 l			
7002055530450	Maner	3 pcs			
A004021505	Cremon 1200-1400 1A E15 TOP	3 pcs			
A004030001	Ghidaj Tija Pt A00402/06	3 pcs			
A330312600	Suport Foarfece A De Frezat A12 B20	3 pcs			
A340302602	Balama A De Frezat B20 A12 SX	3 pcs			
A343310500	Balama Superioara A	3 pcs			
A371040214	Kit Capac Cercevea SX TESI D40 Bronzat Deschis	3 pcs			
A380100502	Opozant Top Bloc S17 A12	9 pcs			
AT 201	Bait	1.325 kg			
AZ2130	Lac	1.325 l			
GGT	Garnitura geam	20.652 m			
M 08	Curatare manuala rame, gauri aerisire	18 op			
M 09	Curatare manuala cercevele, gauri aerisire	12 op			
M 10	Manopera feronerie	3 op			
M 12	Manipulare profile /ml profil	33 op			
M 14	Taiere geam /perimetru	6 op			
M 15	Lipire termopan	6 op			
M 16	Izolare termopan	6 op			
M 17	Pregatire, incarcare /ochi	6 op			
M 19	Fixare rama /perimetru	6 op			
M 20	Montare geam /geam	6 op			
M 21	Reglare feronerie /ccv	3 op			
M 24	Demontare tamplarie veche, mediu	6 op			
M 27	Manopera 1 min	6 op			
M 29	Debitare PVC - 2 capete	33 op			
M 34	Frezare montant si fixare	3 op			

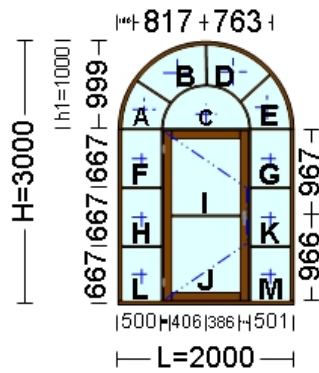

View outer. Opening outer.

**Component : 02.U1**

Size:	2,000.0 mm x 3,000.0 mm	
Profile System:	Molid 68 / Molid	
Hardware:	AGB Standard	
Glass:	GT Clar-Clar 4-14-4; Geam Float 4 mm	
Surface:	5.571	sqm
Quantity:	1	pcs

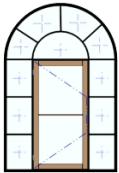

**Subcomponent Element :**

Code	Description	Qty	Dimensions	1°	2°	Pos
IV68/78 01 2 900 - Mol	Toc Fereastră Mobilă DKD, Bară 900 mm	3 pcs	2,000.0 mm	90°	90°	Lft,Down,Rght
IV68/78 01 2 900 - Mol	Toc Fereastră Mobilă DKD, Bară 900 mm	1 pcs	3,141.6 mm	90°	90°	Up
IV68/78 05 2 900 - Mol	Montant DKD, Bară 900 mm	1 pcs	1,914.0 mm	90°	90°	H
IV68/78 05 2 900 - Mol	Montant DKD, Bară 900 mm	1 pcs	446.8 mm	89°	91°	1
IV68/78 05 2 900 - Mol	Montant DKD, Bară 900 mm	1 pcs	449.3 mm	88°	94°	1
IV68/78 05 2 900 - Mol	Montant DKD, Bară 900 mm	1 pcs	1,548.2 mm	91°	91°	H
IV68/78 05 2 900 - Mol	Montant DKD, Bară 900 mm	2 pcs	1,945.0 mm	90°	90°	V,V
IV68/78 05 2 900 - Mol	Montant DKD, Bară 900 mm	4 pcs	445.0 mm	90°	90°	H,H,H,H
IV68/78 05 2 900 - Mol	Montant DKD, Bară 900 mm	1 pcs	448.5 mm	88°	93°	1

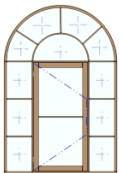

**Subcomponent Element : A**

Code	Description	Qty	Dimensions	1°	2°	Pos
CI-CI 4/16/4	GT Clar-Clar 4-14-4	1 pcs	538.9 x 527.6 mm			

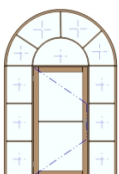

**Subcomponent Element : B**

Code	Description	Qty	Dimensions	1°	2°	Pos
CI-CI 4/16/4	GT Clar-Clar 4-14-4	1 pcs	770.0 x 642.0 mm			

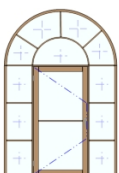

**Subcomponent Element : C**

Code	Description	Qty	Dimensions	1°	2°	Pos
CI-CI 4/16/4	GT Clar-Clar 4-14-4	1 pcs	975.7 x 476.0 mm			

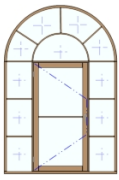

Subcomponent Element : D							
Code	Description	Qty	Dimensions	1°	2°	Pos	
Cl-Cl 4/16/4	GT Clar-Clar 4-14-4	1 pcs	710.2 x 628.5 mm				

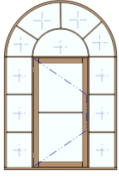

Subcomponent Element : E							
Code	Description	Qty	Dimensions	1°	2°	Pos	
Cl-Cl 4/16/4	GT Clar-Clar 4-14-4	1 pcs	549.2 x 599.5 mm				

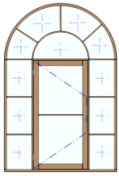

Subcomponent Element : F							
Code	Description	Qty	Dimensions	1°	2°	Pos	
Cl-Cl 4/16/4	GT Clar-Clar 4-14-4	1 pcs	432.0 x 629.7 mm				

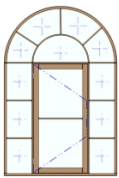

Subcomponent Element : G							
Code	Description	Qty	Dimensions	1°	2°	Pos	
Cl-Cl 4/16/4	GT Clar-Clar 4-14-4	1 pcs	432.0 x 629.7 mm				

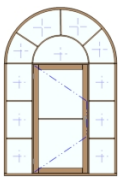

Subcomponent Element : H							
Code	Description	Qty	Dimensions	1°	2°	Pos	
Cl-Cl 4/16/4	GT Clar-Clar 4-14-4	1 pcs	432.0 x 629.7 mm				

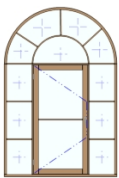

Subcomponent Element : I							
Code	Description	Qty	Dimensions	1°	2°	Pos	
Cl-Cl 4/16/4	GT Clar-Clar 4-14-4	1 pcs	767.0 x 849.5 mm				

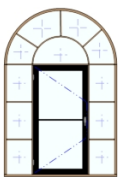

Subcomponent Element : IJ							
Code	Description	Qty	Dimensions	1°	2°	Pos	
IV68/110 04 1 6000 - Mol	Canat Usa T FJ, Bara 6000 mm	1 pcs	1,933.0 mm	90°	90°	Lft	
IV68/110 04 1 6000 - Mol	Canat Usa T FJ, Bara 6000 mm	1 pcs	964.0 mm	90°	90°	Down	
L 90 0	Profil Lacrimar Fereastră	1 pcs	928.0 mm	90°	90°	Down	
IV68/110 04 1 6000 - Mol	Canat Usa T FJ, Bara 6000 mm	1 pcs	1,933.0 mm	90°	90°	Right	
IV68/110 04 1 6000 - Mol	Canat Usa T FJ, Bara 6000 mm	1 pcs	964.0 mm	90°	90°	Up	
IV68/78 05 2 900 - Mol	Montant DKD, Bara 900 mm	1 pcs	780.0 mm	90°	90°	H	

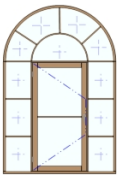
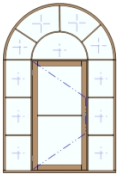
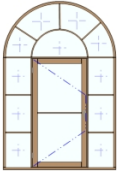
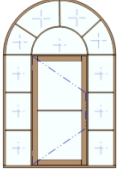
	<b>Subcomponent Element : J</b>						
	<b>Code</b>	<b>Description</b>	<b>Qty</b>	<b>Dimensions</b>	<b>1°</b>	<b>2°</b>	<b>Pos</b>
	334-35	Geam Float 4 mm	1 pcs	767.0 x 849.5 mm			
	<b>Subcomponent Element : K</b>						
	<b>Code</b>	<b>Description</b>	<b>Qty</b>	<b>Dimensions</b>	<b>1°</b>	<b>2°</b>	<b>Pos</b>
	Cl-Cl 4/16/4	GT Clar-Clar 4-14-4	1 pcs	432.0 x 629.7 mm			
	<b>Subcomponent Element : L</b>						
	<b>Code</b>	<b>Description</b>	<b>Qty</b>	<b>Dimensions</b>	<b>1°</b>	<b>2°</b>	<b>Pos</b>
	Cl-Cl 4/16/4	GT Clar-Clar 4-14-4	1 pcs	432.0 x 598.7 mm			
	<b>Subcomponent Element : M</b>						
	<b>Code</b>	<b>Description</b>	<b>Qty</b>	<b>Dimensions</b>	<b>1°</b>	<b>2°</b>	<b>Pos</b>
	Cl-Cl 4/16/4	GT Clar-Clar 4-14-4	1 pcs	432.0 x 598.7 mm			

<b>Hardware and Accessories</b>						
<b>Code</b>	<b>Description</b>	<b>Qty</b>	<b>Dimensions</b>	<b>1°</b>	<b>2°</b>	<b>Pos</b>
1152	Garnitura Usa	5.794	m			
1205	Garnitura	9.142	m			
475/85	Grund	1.140	l			
7002055530450	Maner	1	pcs			
A004021508	Cremon 1800-2000 1A E15 TOP	1	pcs			
A004030001	Ghidaj Tija Pt A00402/06	1	pcs			
A330312600	Suport Foarfece A De Frezat A12 B20	1	pcs			
A340302602	Balama A De Frezat B20 A12 SX	1	pcs			
A343310500	Balama Superioara A	1	pcs			
A371040214	Kit Capac Cercevea SX TESI D40 Bronzat Deschis	1	pcs			
A380100502	Opozant Top Bloc S17 A12	4	pcs			
AT 201	Bait	1.140	kg			
AZ2130	Lac	1.140	l			
GGT	Garnitura geam	29.298	m			
M 01	Debitare unghi variabil	4	op			
M 02	Curbare profil	1	op			
M 08	Curatare manuala rame, gauri aerisire	4	op			
M 09	Curatare manuala cercevele, gauri aerisire	4	op			
M 10	Manopera feronerie	2	op			
M 12	Manipulare profile /ml profil	21	op			
M 14	Taiere geam /perimetru	13	op			
M 15	Lipire termopan	13	op			
M 16	Izolare termopan	13	op			
M 17	Pregatire, incarcare /ochi	1	op			
M 19	Fixare rama /perimetru	1	op			
M 20	Montare geam /geam	13	op			

M 21	Reglare feronerie /ccv	1	op				
M 24	Demontare tamplarie veche, mediu	1	op				
M 27	Manopera 1 min	1	op				
M 29	Debitare PVC - 2 capete	20	op				
M 30	Lipire PVC - 1 capat	2	op				
M 34	Frezare montant si fixare	12	op				

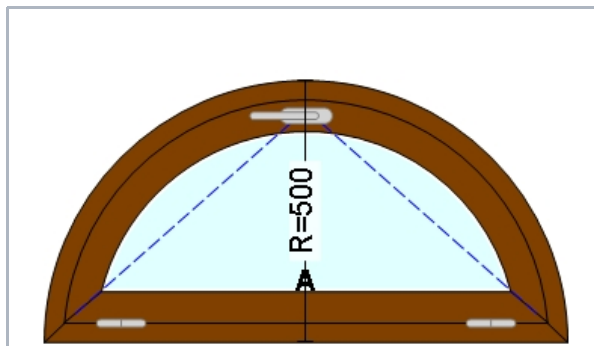

Component : 03.F2		
Size:	1,000.0 mm x 500.0 mm	
Profile System:	Molid 68 / Molid	
Hardware:	AGB Standard	
Glass:	GT Clar-Clar 4-14-4	
Surface:	0.393	sqm
Quantity:	5	pcs

View inner. Opening inner.

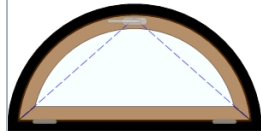

Subcomponent Element :						
Code	Description	Qty	Dimensions	1°	2°	Pos
IV68/78 01 2 900 - Mol	Toc Fereastră Mobilă DKD, Bară 900 mm	5 pcs	1,570.8 mm	46°	46°	Up
IV68/78 01 2 900 - Mol	Toc Fereastră Mobilă DKD, Bară 900 mm	5 pcs	1,000.0 mm	44°	44°	Down

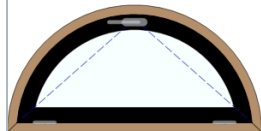

Subcomponent Element : A						
Code	Description	Qty	Dimensions	1°	2°	Pos
IV68/78 02 2 900 - Mol	Canat Fereastră DKD, Bară 900 mm	5 pcs	1,323.9 mm	43°	43°	Up
IV68/78 02 2 900 - Mol	Canat Fereastră DKD, Bară 900 mm	5 pcs	926.4 mm	40°	40°	Down

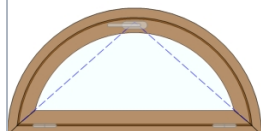

Subcomponent Element : A						
Code	Description	Qty	Dimensions	1°	2°	Pos
CI-CI 4/16/4	GT Clar-Clar 4-14-4	5 pcs	782.3 x 306.0 mm			

Hardware and Accessories						
Code	Description	Qty	Dimensions	1°	2°	
1205	Garnitura	12.854	m			
1208	Garnitura	11.252	m			
475/85	Grund	0.916	l			
AT 201	Bait	0.916	kg			
AZ2130	Lac	0.916	l			
GGT	Garnitura geam	9.009	m			
M 02	Curbare profil	5	op			
M 08	Curatare manuala rame, gauri aerisire	10	op			
M 09	Curatare manuala cercevele, gauri aerisire	10	op			
M 10	Manopera feronerie	5	op			
M 12	Manipulare profile /ml profil	20	op			
M 14	Taiere geam /perimetru	5	op			
M 15	Lipire termopan	5	op			
M 16	Izolare termopan	5	op			
M 17	Pregatire, incarcare /ochi	5	op			
M 19	Fixare rama /perimetru	5	op			
M 20	Montare geam /geam	5	op			
M 21	Reglare feronerie /ccv	5	op			

M 24	Demontare tamplarie veche, mediu	5	op				
M 27	Manopera 1 min	5	op				
M 29	Debitare PVC - 2 capete	20	op				
M 30	Lipire PVC - 1 capat	20	op				

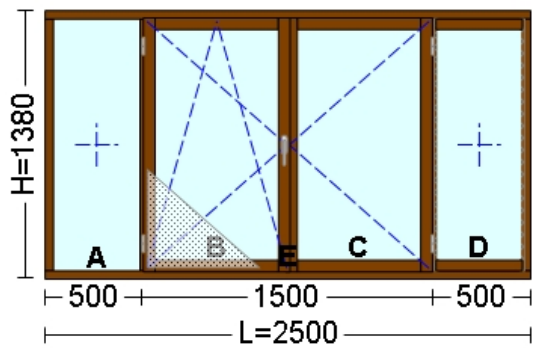

**Component : 04.F3 + Plasa**

Size:	2,500.0 mm x 1,380.0 mm	
Profile System:	Molid 68 / Molid	
Hardware:	AGB Standard	
Glass:	GT Clar-Clar 4-14-4	
Surface:	5.360	sqm
Quantity:	2	pcs

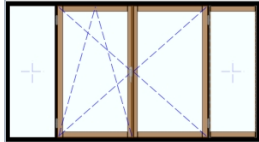
View inner. Opening inner.

**Subcomponent Element :**

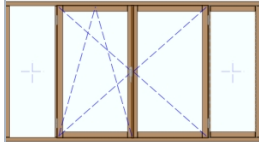
Code	Description	Qty	Dimensions	1°	2°	Pos
IV68/78 01 2 900 - Mol	Toc Fereastră Mobilă DKD, Bară 900 mm	2 pcs	1,380.0 mm	90°	90°	Lft
IV68/78 01 2 900 - Mol	Toc Fereastră Mobilă DKD, Bară 900 mm	2 pcs	2,500.0 mm	90°	90°	Down
IV68/78 01 2 900 - Mol	Toc Fereastră Mobilă DKD, Bară 900 mm	2 pcs	1,380.0 mm	90°	90°	Rght
IV68/78 01 2 900 - Mol	Toc Fereastră Mobilă DKD, Bară 900 mm	2 pcs	2,500.0 mm	90°	90°	Up
IV68/78 05 2 900 - Mol	Montant DKD, Bară 900 mm	4 pcs	1,294.0 mm	90°	90°	V,V

**Subcomponent Element : A**

Code	Description	Qty	Dimensions	1°	2°	Pos
Cl-Cl 4/16/4	GT Clar-Clar 4-14-4	2 pcs	432.0 x 1,281.0 mm			

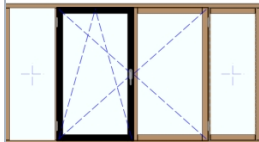
**Subcomponent Element : B**

Code	Description	Qty	Dimensions	1°	2°	Pos
IV68/78 02 2 900 - Mol	Canat Fereastră DKD, Bară 900 mm	2 pcs	1,306.0 mm	90°	90°	Lft
IV68/78 02 2 900 - Mol	Canat Fereastră DKD, Bară 900 mm	2 pcs	755.0 mm	90°	90°	Down
IV68/78 02 2 900 - Mol	Canat Fereastră DKD, Bară 900 mm	2 pcs	1,306.0 mm	90°	90°	Rght
IV68/78 02 2 900 - Mol	Canat Fereastră DKD, Bară 900 mm	2 pcs	755.0 mm	90°	90°	Up

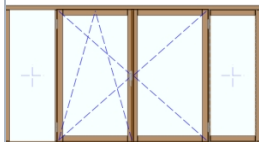
**Subcomponent Element : B**

Code	Description	Qty	Dimensions	1°	2°	Pos
Cl-Cl 4/16/4	GT Clar-Clar 4-14-4	2 pcs	622.0 x 1,173.0 mm			

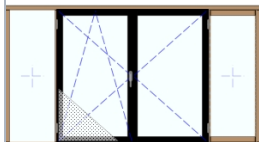
**Subcomponent Element : BC**

Code	Description	Qty	Dimensions	1°	2°	Pos
IV68/78 09 2 900 - Mol	Inversor DKD, Bară 900 mm	2 pcs	1,270.0 mm	90°	90°	1

Subcomponent Element : C		Code	Description	Qty	Dimensions	1°	2°	Pos
	IV68/78 02 2 900 - Mol	Canat Fereastră DKD, Bara 900 mm	2 pcs	1,306.0 mm	90°	90°	Lft	
	IV68/78 02 2 900 - Mol	Canat Fereastră DKD, Bara 900 mm	2 pcs	755.0 mm	90°	90°	Down	
	IV68/78 02 2 900 - Mol	Canat Fereastră DKD, Bara 900 mm	2 pcs	1,306.0 mm	90°	90°	Rght	
	IV68/78 02 2 900 - Mol	Canat Fereastră DKD, Bara 900 mm	2 pcs	755.0 mm	90°	90°	Up	
Subcomponent Element : C		Code	Description	Qty	Dimensions	1°	2°	Pos
	CI-CI 4/16/4	GT Clar-Clar 4-14-4	2 pcs	622.0 x 1,173.0 mm				
Subcomponent Element : D		Code	Description	Qty	Dimensions	1°	2°	Pos
	IV68/78 07 2 900 - Mol	Profil Compensare DKD, Bara 900 mm	4 pcs	445.0 mm	90°	90°	Down, Up	
Subcomponent Element : D		Code	Description	Qty	Dimensions	1°	2°	Pos
	CI-CI 4/16/4	GT Clar-Clar 4-14-4	2 pcs	432.0 x 1,173.0 mm				
Subcomponent Element : E		Code	Description	Qty	Dimensions	1°	2°	Pos
	DKD4P - Mol	Toc plasa insecte	2 pcs	1,294.0 mm	90°	90°	Lft	
	DKD4P - Mol	Toc plasa insecte	2 pcs	1,476.0 mm	90°	90°	Down	
	DKD4P - Mol	Toc plasa insecte	2 pcs	1,294.0 mm	90°	90°	Rght	
	DKD4P - Mol	Toc plasa insecte	2 pcs	1,476.0 mm	90°	90°	Up	
Subcomponent Element : E		Code	Description	Qty	Dimensions	1°	2°	Pos
	52120	Plasa Insecte 120 cm	2 pcs	1,448.2 x 1,266.2 mm				

Hardware and Accessories							
Code	Description	Qty	Dimensions	1°	2°	Pos	
1205	Garnitura	28.380	m				
1208	Garnitura	16.488	m				
475/85	Grund	1.902	l				
7002055530450	Maner	2	pcs				
A200090002	Coltar 1 Bloc Gr. 2	2	pcs				
A200140003	Inchidere Supp Ar 1250-1800	2	pcs				
A200170504	Opozant Top Reg S17 A12 1F	4	pcs				
A200190001	Compensator Balama AR KG130	4	pcs				
A200360201	Zavor Inferior A11	2	pcs				

A200360202	Zavor Superior A11	2	pcs				
A301101505	Cremon TESI E15 1200-1400	2	pcs				
A309060001	Dispozitiv De Falsa Manevra	2	pcs				
A320110003	Foarfece Aplicat Gr.3	2	pcs				
A330312600	Suport Foarfece A De Frezat A12 B20	6	pcs				
A340302601	Balama A De Frezat B20 A12 DX	2	pcs				
A340302602	Balama A De Frezat B20 A12 SX	2	pcs				
A343310500	Balama Superioara A	2	pcs				
A371040114	Kit Capac Cercevea DX TESI D40 Bronzat Deschis	2	pcs				
A371040214	Kit Capac Cercevea SX TESI D40 Bronzat Deschis	2	pcs				
A380100502	Opozant Top Bloc S17 A12	4	pcs				
A380121103	Opozant DSS A11 8+6 E 8+7 SX	2	pcs				
AT 201	Bait	1.902	kg				
AZ2130	Lac	1.902	l				
GGT	Garnitura geam	38.490	m				
M 06	Frezare inversor (montant orb) si fixare	4	op				
M 08	Curatare manuala rame, gauri aerisire	20	op				
M 09	Curatare manuala cercevele, gauri aerisire	16	op				
M 10	Manopera feronerie	6	op				
M 12	Manipulare profile /ml profil	42	op				
M 14	Taiere geam /perimetru	10	op				
M 15	Lipire termopan	10	op				
M 16	Izolare termopan	10	op				
M 17	Pregatire, incarcare /ochi	6	op				
M 19	Fixare rama /perimetru	6	op				
M 20	Montare geam /geam	10	op				
M 21	Reglare feronerie /ccv	4	op				
M 24	Demontare tamplarie veche, mediu	6	op				
M 27	Manopera 1 min	6	op				
M 29	Debitare PVC - 2 capete	40	op				
M 34	Frezare montant si fixare	4	op				