

Glass Panel

Project: OFR06583 - Demo Lemn Stratificat / Date: 12/02/2009
 Delivery Date: 28/11/2007

Categoria: Glass

Grup Consum: Glass

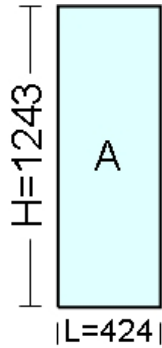

Component: 01.F1
 Position: A
 Code: CI-CI 4/16/4
 Description: GT Clar-Clar 4-14-4
 Quantity: 3 pcs
 Size: L:424.0 mm x H:1,243.0 mm
 Surface: 0.527 sqm

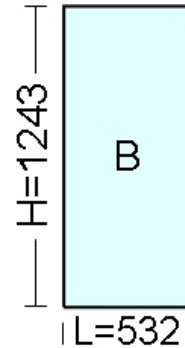

Component: 01.F1
 Position: B
 Code: CI-CI 4/16/4
 Description: GT Clar-Clar 4-14-4
 Quantity: 3 pcs
 Size: L:532.0 mm x H:1,243.0 mm
 Surface: 0.661 sqm

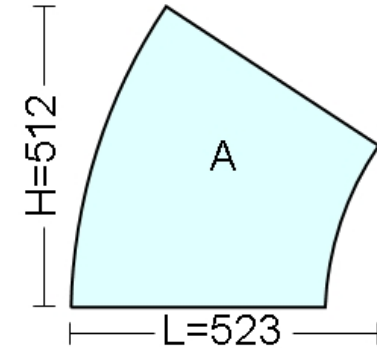

Component: 02.U1
 Position: A
 Code: CI-CI 4/16/4
 Description: GT Clar-Clar 4-14-4
 Quantity: 1 pcs
 Size: L:538.9 mm x H:527.6 mm
 Surface: 0.181 sqm

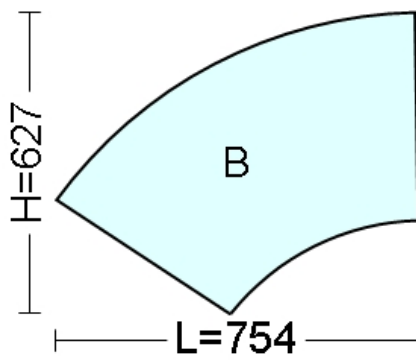

Component: 02.U1
 Position: B
 Code: CI-CI 4/16/4
 Description: GT Clar-Clar 4-14-4
 Quantity: 1 pcs
 Size: L:770.0 mm x H:642.0 mm
 Surface: 0.286 sqm

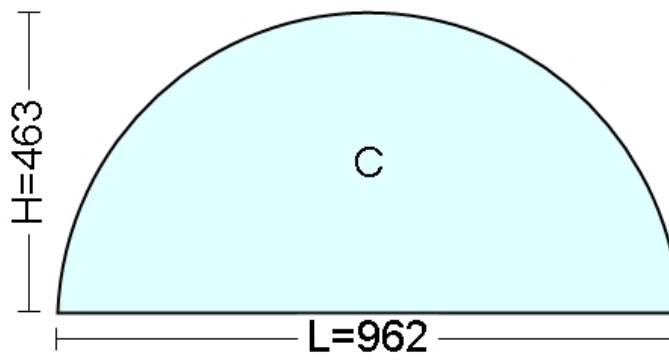

Component: 02.U1
 Position: C
 Code: CI-CI 4/16/4
 Description: GT Clar-Clar 4-14-4
 Quantity: 1 pcs
 Size: L:975.7 mm x H:476.0 mm
 Surface: 0.346 sqm

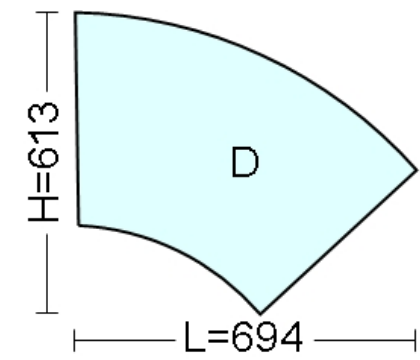

Component: 02.U1
 Position: D
 Code: CI-CI 4/16/4
 Description: GT Clar-Clar 4-14-4
 Quantity: 1 pcs
 Size: L:710.2 mm x H:628.5 mm
 Surface: 0.261 sqm

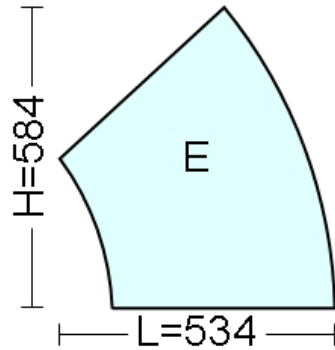

Component: 02.U1
 Position: E
 Code: CI-CI 4/16/4
 Description: GT Clar-Clar 4-14-4
 Quantity: 1 pcs
 Size: L:549.2 mm x H:599.5 mm
 Surface: 0.204 sqm

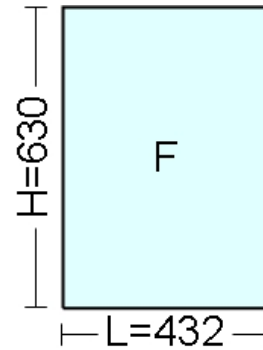

Component: 02.U1
 Position: F
 Code: CI-CI 4/16/4
 Description: GT Clar-Clar 4-14-4
 Quantity: 1 pcs
 Size: L:432.0 mm x H:629.7 mm
 Surface: 0.272 sqm

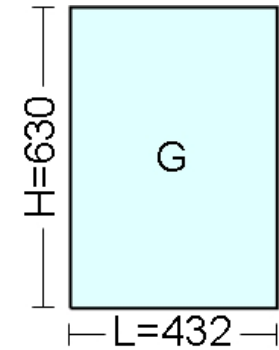

Component: 02.U1
 Position: G
 Code: CI-CI 4/16/4
 Description: GT Clar-Clar 4-14-4
 Quantity: 1 pcs
 Size: L:432.0 mm x H:629.7 mm
 Surface: 0.272 sqm

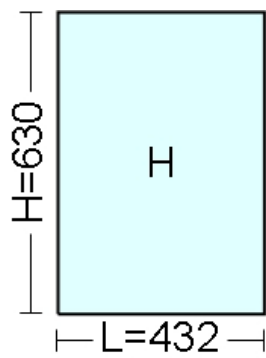

Component: 02.U1
 Position: H
 Code: CI-CI 4/16/4
 Description: GT Clar-Clar 4-14-4
 Quantity: 1 pcs
 Size: L:432.0 mm x H:629.7 mm
 Surface: 0.272 sqm

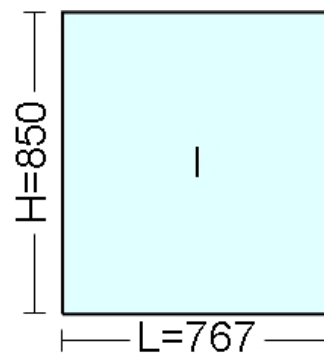

Component: 02.U1
 Position: I
 Code: CI-CI 4/16/4
 Description: GT Clar-Clar 4-14-4
 Quantity: 1 pcs
 Size: L:767.0 mm x H:849.5 mm
 Surface: 0.652 sqm

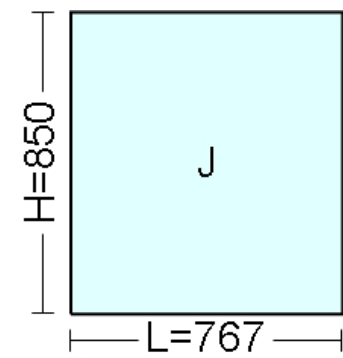

Component: 02.U1
 Position: J
 Code: 334-35
 Description: Geam Float 4 mm
 Quantity: 1 pcs
 Size: L:767.0 mm x H:849.5 mm
 Surface: 0.652 sqm

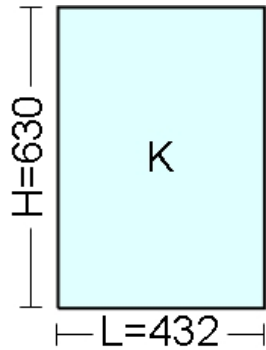

Component: 02.U1
 Position: K
 Code: CI-CI 4/16/4
 Description: GT Clar-Clar 4-14-4
 Quantity: 1 pcs
 Size: L:432.0 mm x H:629.7 mm
 Surface: 0.272 sqm

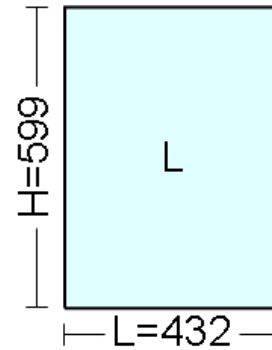

Component: 02.U1
 Position: L
 Code: CI-CI 4/16/4
 Description: GT Clar-Clar 4-14-4
 Quantity: 1 pcs
 Size: L:432.0 mm x H:598.7 mm
 Surface: 0.259 sqm

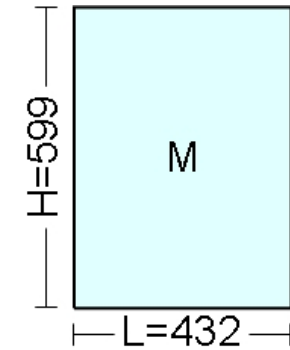

Component: 02.U1
 Position: M
 Code: CI-CI 4/16/4
 Description: GT Clar-Clar 4-14-4
 Quantity: 1 pcs
 Size: L:432.0 mm x H:598.7 mm
 Surface: 0.259 sqm

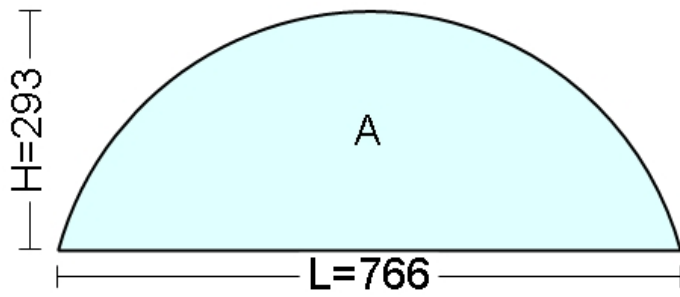

Component: 03.F2
 Position: A
 Code: CI-CI 4/16/4
 Description: GT Clar-Clar 4-14-4
 Quantity: 5 pcs
 Size: L:782.3 mm x H:306.0 mm
 Surface: 0.166 sqm

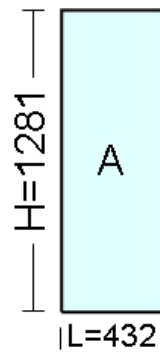

Component: 04.F3 + Plasa
 Position: A
 Code: CI-CI 4/16/4
 Description: GT Clar-Clar 4-14-4
 Quantity: 2 pcs
 Size: L:432.0 mm x H:1,281.0 mm
 Surface: 0.553 sqm

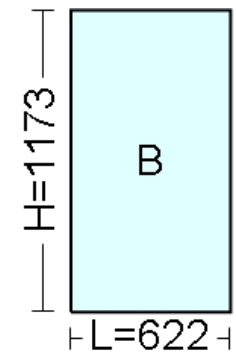

Component: 04.F3 + Plasa
 Position: B
 Code: CI-CI 4/16/4
 Description: GT Clar-Clar 4-14-4
 Quantity: 2 pcs
 Size: L:622.0 mm x H:1,173.0 mm
 Surface: 0.730 sqm

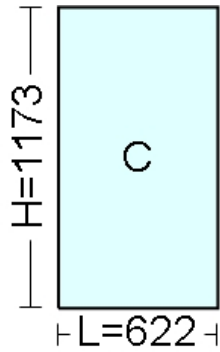

Component: 04.F3 + Plasa
 Position: C
 Code: CI-CI 4/16/4
 Description: GT Clar-Clar 4-14-4
 Quantity: 2 pcs
 Size: L:622.0 mm x H:1,173.0 mm
 Surface: 0.730 sqm

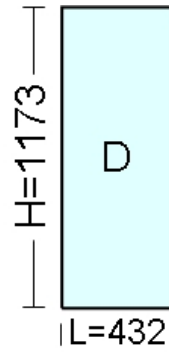

Component: 04.F3 + Plasa
 Position: D
 Code: CI-CI 4/16/4
 Description: GT Clar-Clar 4-14-4
 Quantity: 2 pcs
 Size: L:432.0 mm x H:1,173.0 mm
 Surface: 0.507 sqm

Categoria: Insect screens
 Grup Consum: Glass

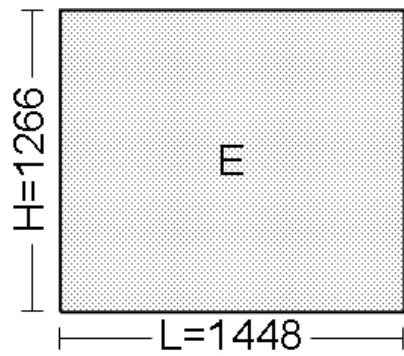

Component: 04.F3 + Plasa
Position: E
Code: 52120
Description: Plasa Insecte 120 cm
Quantity: 2 pcs
Size: L:1,448.2 mm x H:1,266.2 mm
Surface: 1.834 sqm